

# Press fix Frame Hardware

## Quality, economy and efficiency



9418  
Press-fix hangers fitted to the frame back usually sit below the rim of a hollow back, so frames hang flush on the wall.



5788  
These hangers also make it easier to align frames being hung in groups.

### 1 Hole Hangers

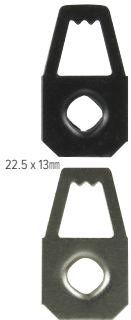

22.5 x 13mm

### 1 Hole Hinged Hanger



32 x 12mm

### Saw Tooth Hanger- 58mm



58 x 8mm

The new LION V Hook for pictures works well with sawtooth hangers

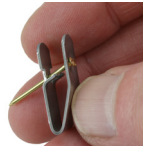

### 2 Hole Hangers

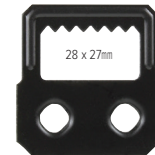

28 x 27mm



### 2 Hole Hinged Hanger

1:1



32 x 24mm

### 3 Hole Hinged Hanger

1:1



32 x 36mm

### 3 Hole Hinged Hanger

1:1

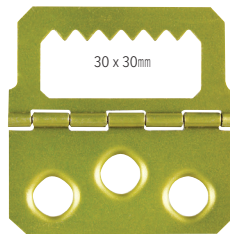

30 x 30mm

### 4 Hole Hanging Plate

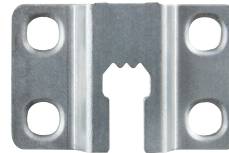

22.5 x 35mm

### 6 Hole Hanging Plate

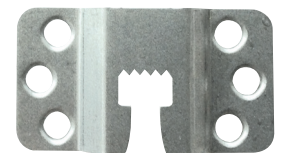

50 x 28mm

**SE100**  
**Manual Press**  
**Only for press-fix**  
**steel struts**



**SH200**  
**Manual Press**  
**For press-fix**  
**hangers,**  
**strut**  
**hinges &**  
**steel struts**

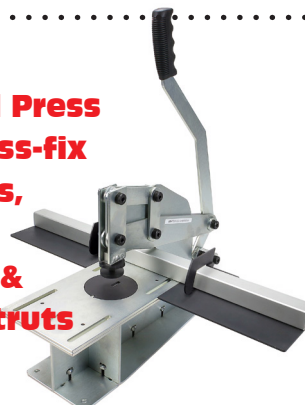

**SH100**  
**Manual Press**  
**For press-fix**  
**hangers,**  
**strut hinges,**  
**rivets &**  
**steel struts**

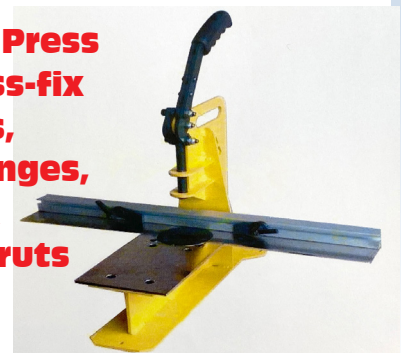



# SH100

## Manual press

### For press-fix hangers, strut hinges & rivets

The SH100 is the ideal multi-purpose press for a well-equipped framing workshop. It handles three key tasks:

- Fixing most of the Alfamacchine press-fix hangers and hardware range
- Fits strut hinges to struts to make easel backs
- The only press which can insert and set hollow rivets

In each case the appropriate locator disc and guides must be fitted. These are at extra cost and can be purchased as required.

See p.4/5 for details of the range of press-fix hangers, strut hinges and locator discs.

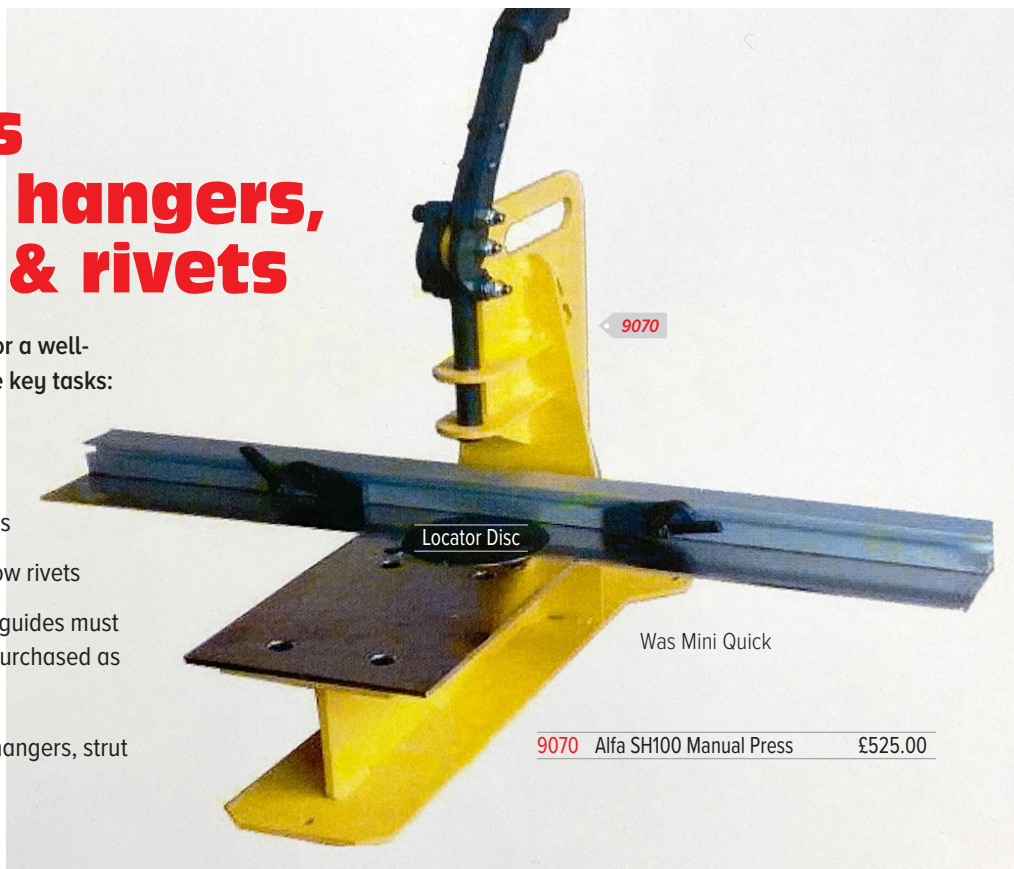

9070 Alfa SH100 Manual Press £525.00

## Rivets to fix D-Rings

Locator kit 9125 fitted to the SH100 inserts and sets hollow rivets which are self-piercing. The special design of the locator disc allows for perfect alignment of the upper and lower parts, which is very important.

#PG03-0068-0068. This kit only fits the SH100

9125 Locator Kit Rivets £250.69



Rivets set flat and smooth both sides



# SE100

## Manual Press

### For fixing steel struts to back boards



For SH100 and SH200 presses use Strut Locator Disc & Positioner Kit 9561 #PG38-0172-0172

9561 Locator Disc and Positioning Guide £153.92

7515	Alfa SE100 Manual Press		£150.00
7516	Short Struts 112mm	pk 50	£15.76
7517	Long Struts 147mm	pk 50	£16.73
7518	Moulded Tips Black	pk 50	£3.53
7519	Moulded Tips Red	pk 50	£3.53
7567	Moulded Tips Grey	pk 50	£3.53



# SH200

## Manual press

### For press-fix hangers, strut hinges & steel struts

The Alfa SH200 manual press installs most items of press-fix frame hangers, strut hinges and steel struts.

The special design of the lever action means that a pull on the handle creates pressure to squeeze and set the starbursts on the press-fix hardware. It works on hardboard, MDF and on firmer paper boards. Easy to adjust for board thicknesses up to about 4mm.

For each hanger the appropriate Locator Disc and guides must be fitted. These are all at extra cost and can be purchased as required. See p.4/5 for details of press-fix hangers, strut hinges and locator discs.

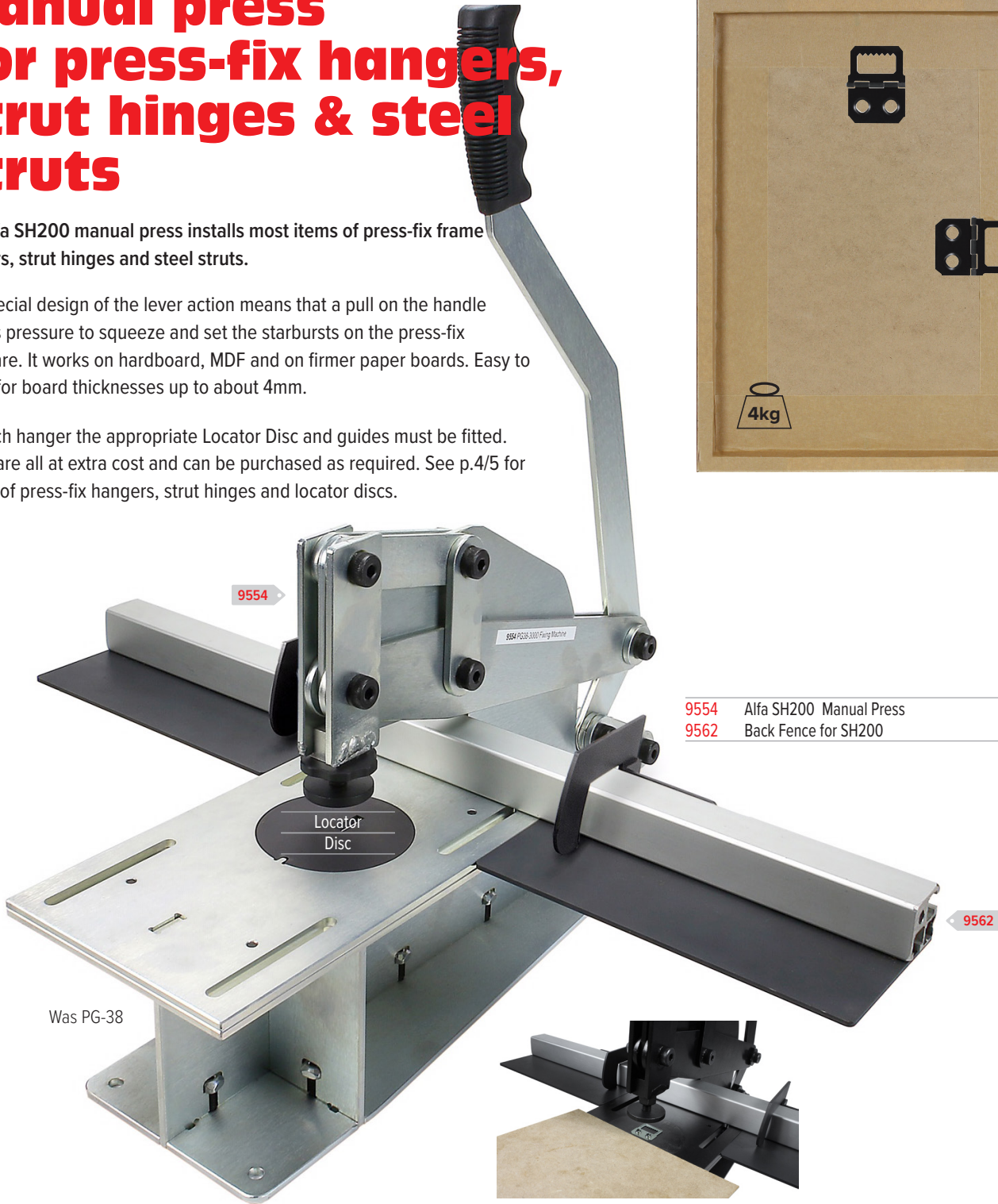

9554	Alfa SH200 Manual Press	£425.00
9562	Back Fence for SH200	£114.27

Was PG-38

### Hammers for SH100

40mm Long

#PG03-0061-0061

Included with 9070



9126	Hammer 40mm dia Long	£65.86
------	-------------------------	--------

60mm Long

#PG38-0060-0060



9591	Hammer 60mm dia Long	£63.58
------	-------------------------	--------

### Hammers for SH200

40mm Short

#PG38-0000-0021

Included with 9554



9555	Hammer 40mm dia Short	£41.63
------	--------------------------	--------

60mm Short

#PG38-0000-0019



9556	Hammer 60mm dia Short	£43.09
------	--------------------------	--------

# Press fix Hangers and Locator Discs to use with SH100 and SH200 Manual Presses

## 1 Hole Hangers

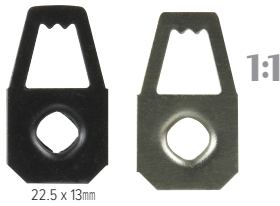

A low-cost hanger for small pictures and photo frames. Well proven over many years.

4625A	1 Hole Hanger	Black	200	£4.40
4625B	1 Hole Hanger	Black	1000	£19.80
5787A	1 Hole Hanger	ZP	200	£3.22

## 1 Hole Hinged Hanger



A neat self-fix hinged hanger. Especially popular on small pictures sold in Europe.

5181	1 Hole Hinged Hanger	Black**	1000	£30.59
------	----------------------	---------	------	--------

## Sawtooth Hanger 58mm



The sawtooth allows the frame to be easily levelled.

9418A	Sawtooth 58mm	Black	200	£7.20
9418B	Sawtooth 58mm	Black	1000	£32.40
9418C	Sawtooth 58mm	Black	5000	£145.80

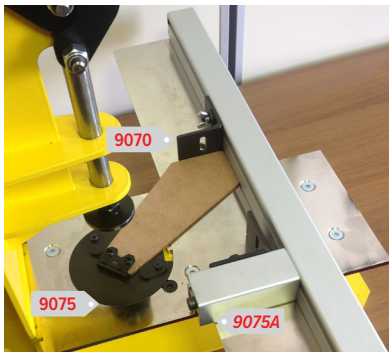

## Fixing a shaped strut to a backing board using press-fix Strut Hinges

Using an Alfa SH100 Press

Insert Locator Disc **9075**.  
Reverse the back fence and fit Locator Stop **9075A**

### Strut Hinges for photo frames

High quality press-fix Strut Hinges for photo frames made in Taiwan by Apple Pie Inc.

**AP06 Strut hinges** 28.6mm x 15.4mm

6349A	Strut Hinge AP06	pk 100	£5.40
6349	Strut Hinge AP06	pk 5,500	£144.21

**AP01 Press-fix Strut hinges** 28.7mm x 18.0mm

5665A	Strut Hinge AP01	pk 100	£5.43
5665	Strut Hinge AP01	pk 4,300	£157.01

### Locator Discs for Strut Hinges

9075 works on both SH100 and SH200

9075	Locator Disc for Strut Hinges	£129.02
9075A	Locator Stop for SH100	£38.24
9560	Locator Bars kit for SH200	£195.89

### Using an Alfa SH200 Press

Insert Locator Disc **9075**  
Fit Locator Bars kit **9560**



Check best prices:  
[www.lionpic.co.uk](http://www.lionpic.co.uk)



The Alfamacchine products in this brochure were introduced during 2019. All should be in stock except the CH Series Coil machines, which are made to order.

They complement their very extensive range of picture framing equipment, all made in Italy. LION have been working with Alfamacchine for nearly 30 years and our team offers full technical sales support with expert parts and service back-up. Contact: [liontech@lionpic.co.uk](mailto:liontech@lionpic.co.uk).



Make your own reference copy of this PUB043. Take four clear A4 punched file pockets, and print and insert the pages. Collate and staple them in three places down the spine. Job done and easy to update.



## 2 Hole Hangers

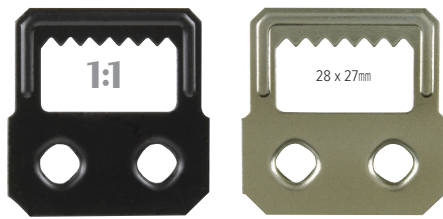

Ideal for medium sized pictures. Two hole fixing is very reliable. Easily bent up by user.

4626A	2 Hole Hanger	Black	100	£4.40
4626B	2 Hole Hanger	Black	500	£19.80
5788A	2 Hole Hanger	ZP	100	£4.55
5788B	2 Hole Hanger	ZP	500	£20.45

## 2 Hole Hinged Hanger



Hinged hangers are easier to use with hooks on art hanging systems.

5789A	2 Hole Hinged Hanger	Black	200	£9.90
5789B	2 Hole Hinged Hanger	Black	1000	£44.55
5789C	2 Hole Hinged Hanger	Black	7500	£321.81

## 3 Hole Hinged Hanger

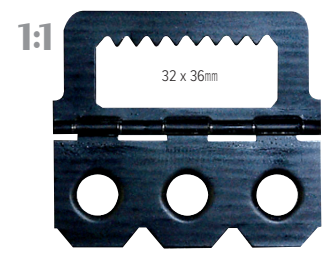

Works well with most hooks on art hanging systems.

9537A	3 Hole Hinged Hanger	Black	200	£13.25
9537B	3 Hole Hinged Hanger	Black	1000	£59.63
9537C	3 Hole Hinged Hanger	Black	5000	£268.31

## 3 Hole Hinged Hanger

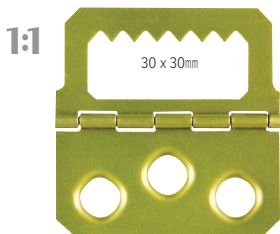

Designed for use with gallery hanging systems. Well proven over many years.

5007A	3 Hole Hinged Hanger	ZP	200	£15.80
5007B	3 Hole Hinged Hanger	ZP	1000	£71.10
5007C	3 Hole Hinged Hanger	ZP	5000	£319.95

## 4 Hole Hanging Plates

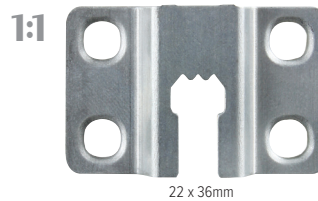

Suitable for frames up to about 700 x 500mm / 30" x 20". Always test. ZP.

266A	4 Hole Plate	ZP	100	£3.25
266B	4 Hole Plate	ZP	1000	£29.62
266C	4 Hole Plate	ZP	5000	£135.42

## 6 Hole Hanging Plate

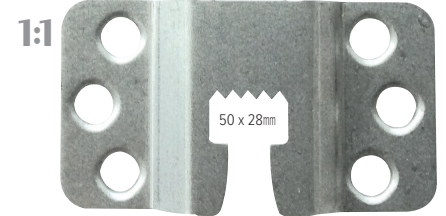

Suitable for frames up to about 1000 x 700mm / 40" x 28". Always test. ZP.

9544A	6 Hole Plate	ZP	100	£4.30
9544B	6 Hole Plate	ZP	1000	£38.70
9544C	6 Hole Plate	ZP	3000	£104.49



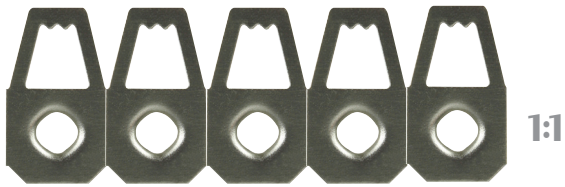

1-Hole Hangers

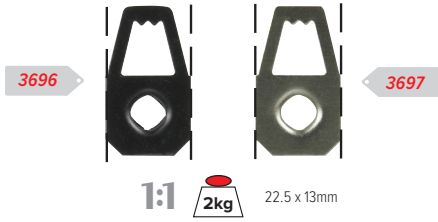

## CH100 Coil

To fix 1 Hole Hangers

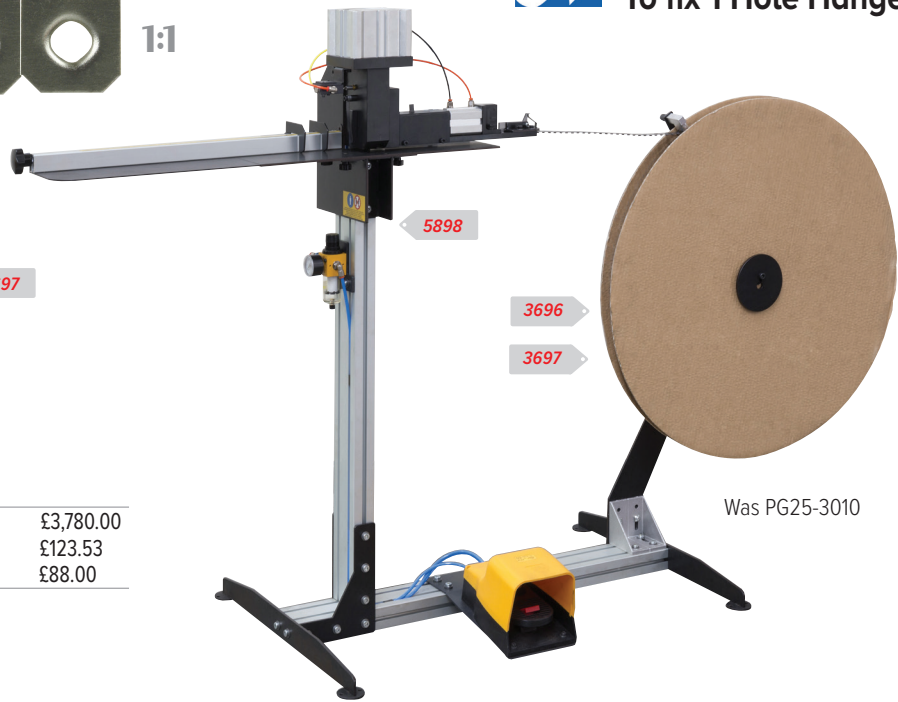

5898	Alfa CH100 Coil Machine		£3,780.00
3696	1 Hole Hanger Black	7,000 coil	£123.53
3697	1 Hole Hanger ZP	7,000 coil	£88.00

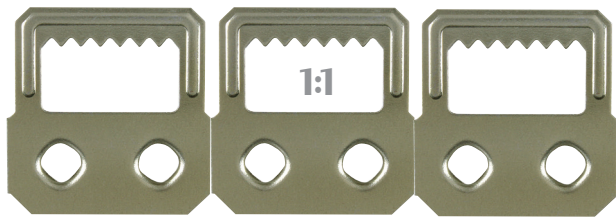

## CH200 Coil

To fix 2 Hole Hangers

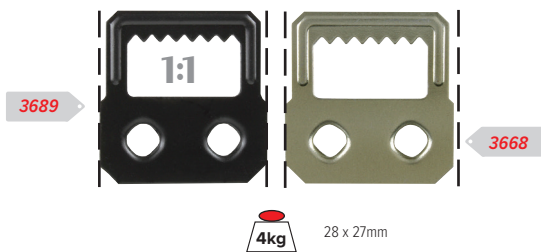

5899	Alfa CH200 Coil Machine		£3,780.00
3689	2 Hole Hanger Black	3,500 coil	£109.34
3668	2 Hole Hanger ZP	3,500 coil	£119.42

## CH500 Coil Dual

Fixes Two Press-fix Hangers in One Operation

The CH Series Coil hanger fixing machines are also available as dual machines, for very high-volume production. Ask our Technical Sales team for more info.

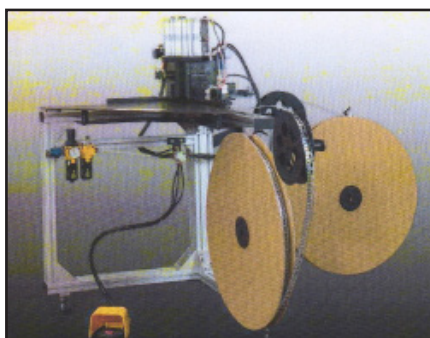

## Press-fix Hangers on coils to fit Cassese machines MF30 & MF40

Some of the Alfamacchine press fix hangers are available on coils in a special format suitable for Cassese coil-fed machines, MF30 and MF40.

Hanger styles as 3696 and 3689.

10147	1 Hole Black	7,000 coil	£118.25	As 1701N
10148	1 Hole ZP	7,000 coil	£95.00	As 1701A
10149	2 Hole Black	3,500 coil	£92.00	As 2702N
10150	2 Hole ZP	3,500 coil	£75.00	As 2702A



**Tough and cost effective semi-automatic machines for the higher volume frame producer.**

All the Alfamachine CH Series Coil press-fix hanger machines are similar in design / They are reliable and cost effective for the higher volume frame producer / Need compressed air but no electric supply / Coil change is fast with the pneumatic feeder system / Easy set-up and adjustment of the hanger as it feeds into the machine.

The pneumatic diaphragm in the operating head is simple and reliable / Air consumption is minimised / Operating pressure 6 to 8 bar / Operating force is kN 5.5 / Board thickness 1 to 4mm / Board size 90 x 130mm up to 600 x 800mm / Overall size 1850 x 560mm, 1200mm high / Weight 60kg / Once a CH Series Coil Machine is built and installed it cannot be changed to fix another type of hanger.

Talk to our Technical Sales Team who will help you select the best model for your needs.



## CH300 Coil

To fix BeBe Hangers



### BeBe 2 Hole Hangers

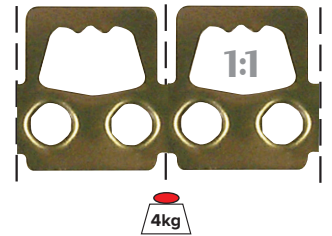

9557	Alfa CH300 Coil Machine	£3,780.00
7863	BeBe Hanger ZP 4,000 coil	£103.50



## CH400 Coil

To fix 4 Hole Hanging Plates

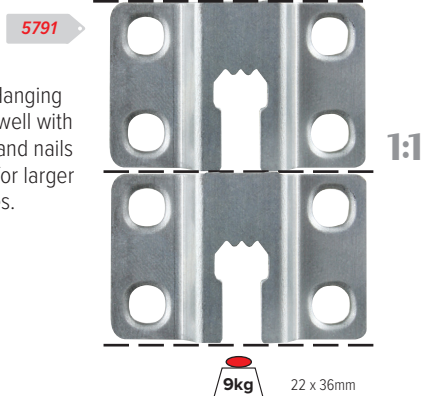

Alfa 4 Hole Hanging Plate works well with most hooks and nails and is ideal for larger poster frames.

9550	Alfa CH400 Coil Machine	£3,780.00
5791	4 Hole Plate 3,500 Coil	£104.06



## CH400 Coil

p.7

5791

10kg



## SH200 Manual Press

p.3

Strut Hinge locators, p.4



SH200 is now silver

## SE100 Manual Press

p.2



### Hinged hangers work well with hooks on Art Hanging Systems

1 Hole p.4



2 Hole p.5

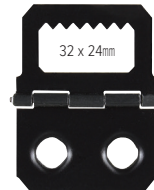

3 Hole p.5

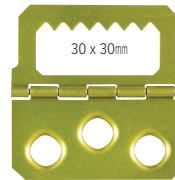

3 Hole p.5



## SH300 Pneumatic Press

Ask for details

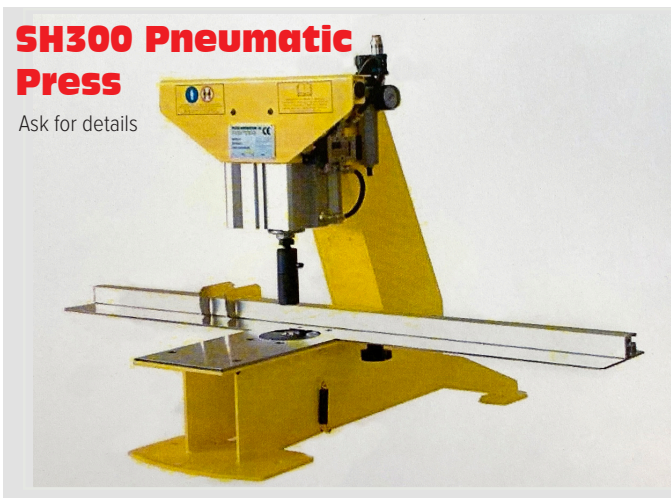

### You are welcome to visit us at LION in Birmingham



See and try the Alfamachine manual presses and press-fix hardware. While with us, see all leading brands of framing equipment and view the outstanding range of LION Mouldings. To help us help you, please let us know you are coming in advance and don't forget our Click & Collect trade counter service.